

PALLET PDF PATTERN A4

【FR2300/150-165】ワイドナパンツ

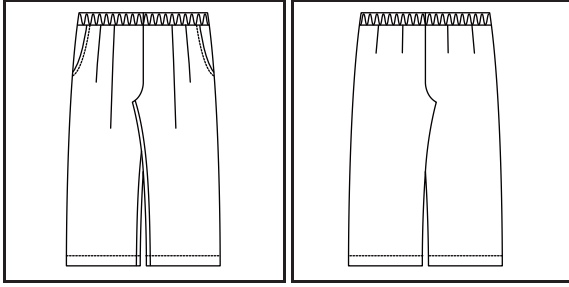

ご利用について

- 全てのページをA4用紙で印刷して下さい。
- 型紙の枠が横195mm×縦282mmで印刷されているかご確認下さい。
- PDFデータの改ざん、複製、転売、アップロードなどの行為は強く禁じております。

この型紙は本紙を合わせA4サイズ用の紙 29 枚となります。下記の通り、貼り合わせてご利用下さい。

A	B	C	D
E	F	G	H
I	J	K	L
M	N	O	P
Q	R	S	T
U	V	W	X
Y	Z	AA	AB

A

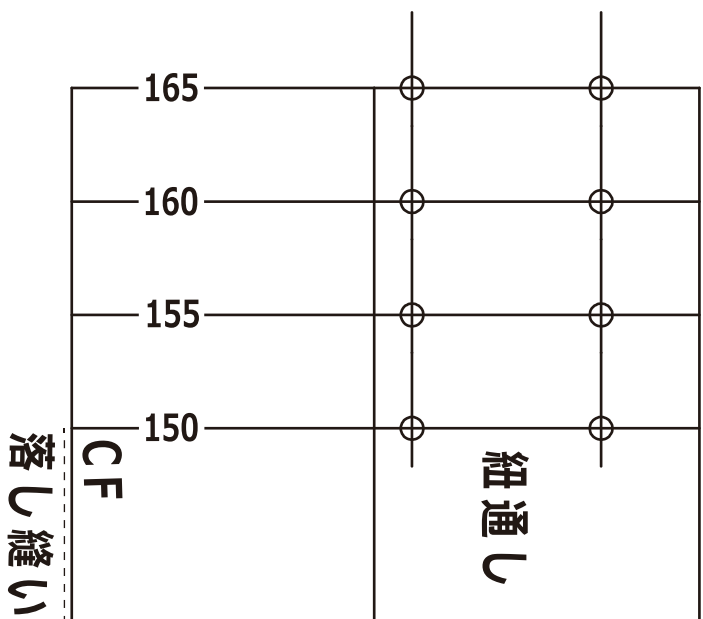

PALLET
FR2300
D:ベルト
表地×1



—165
—160
—155
—150
胸線

CB

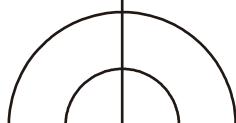

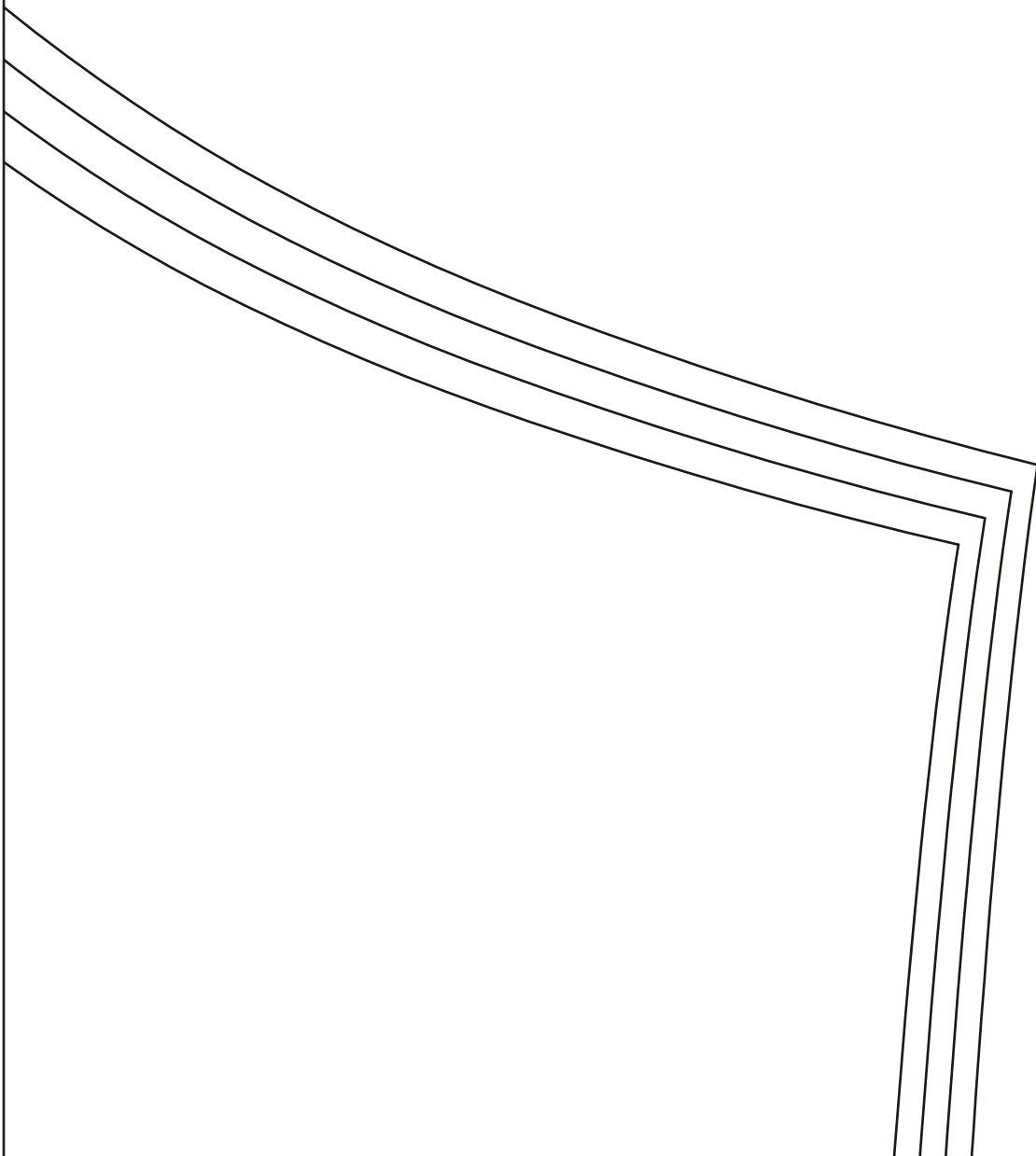



150 155 160 165

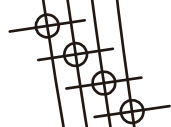

PALLET
FR2300
C: 前ポケット
表地 × 2

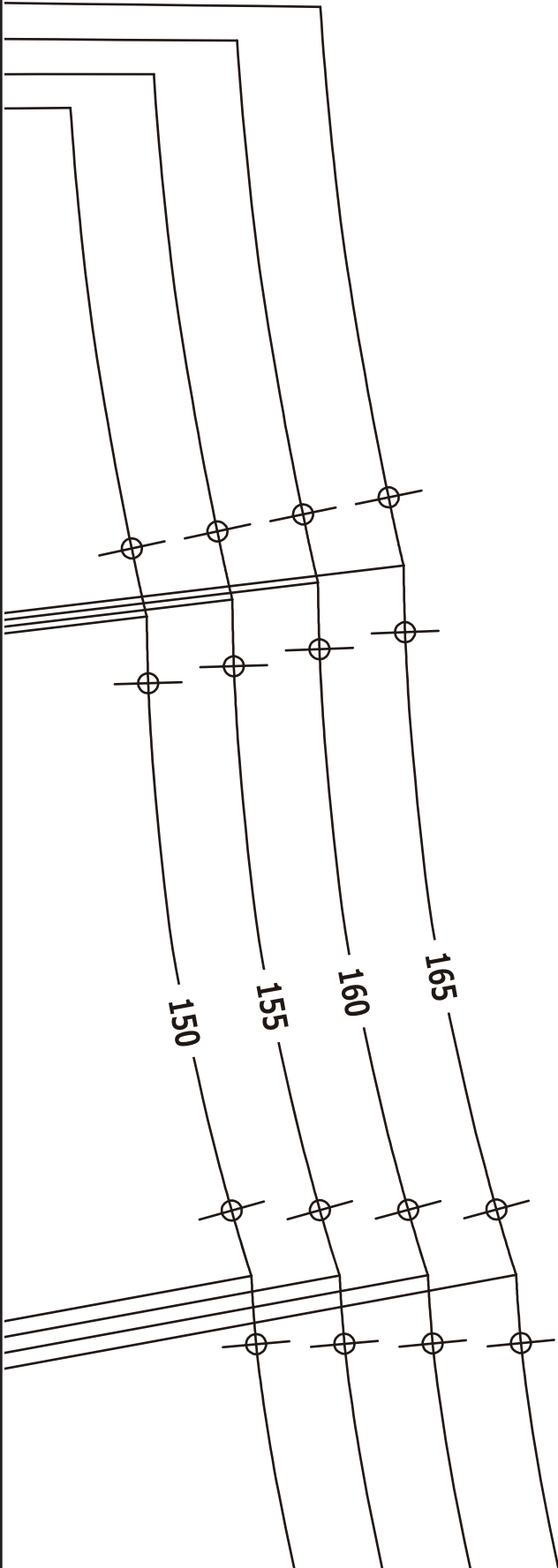



CB

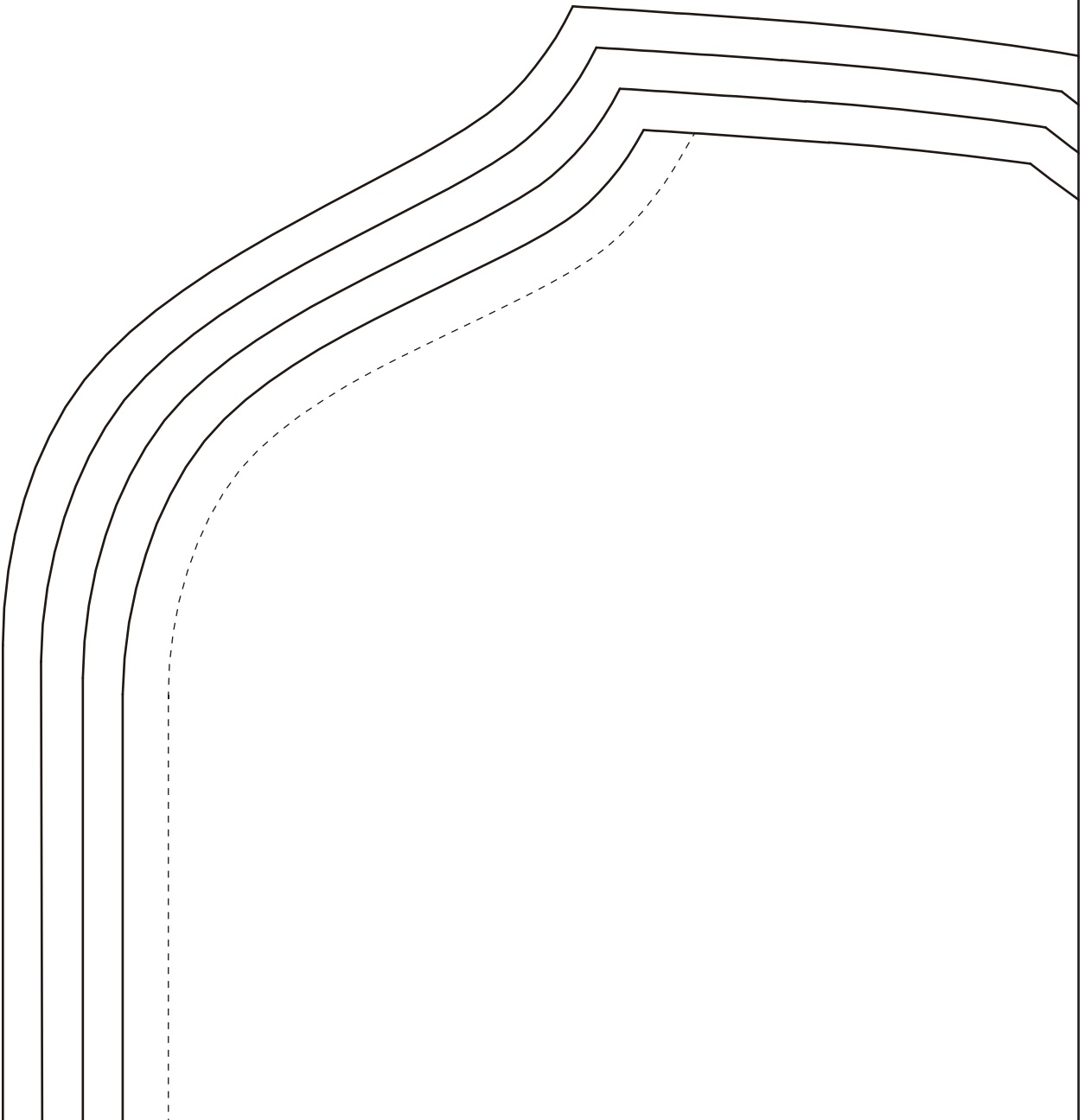

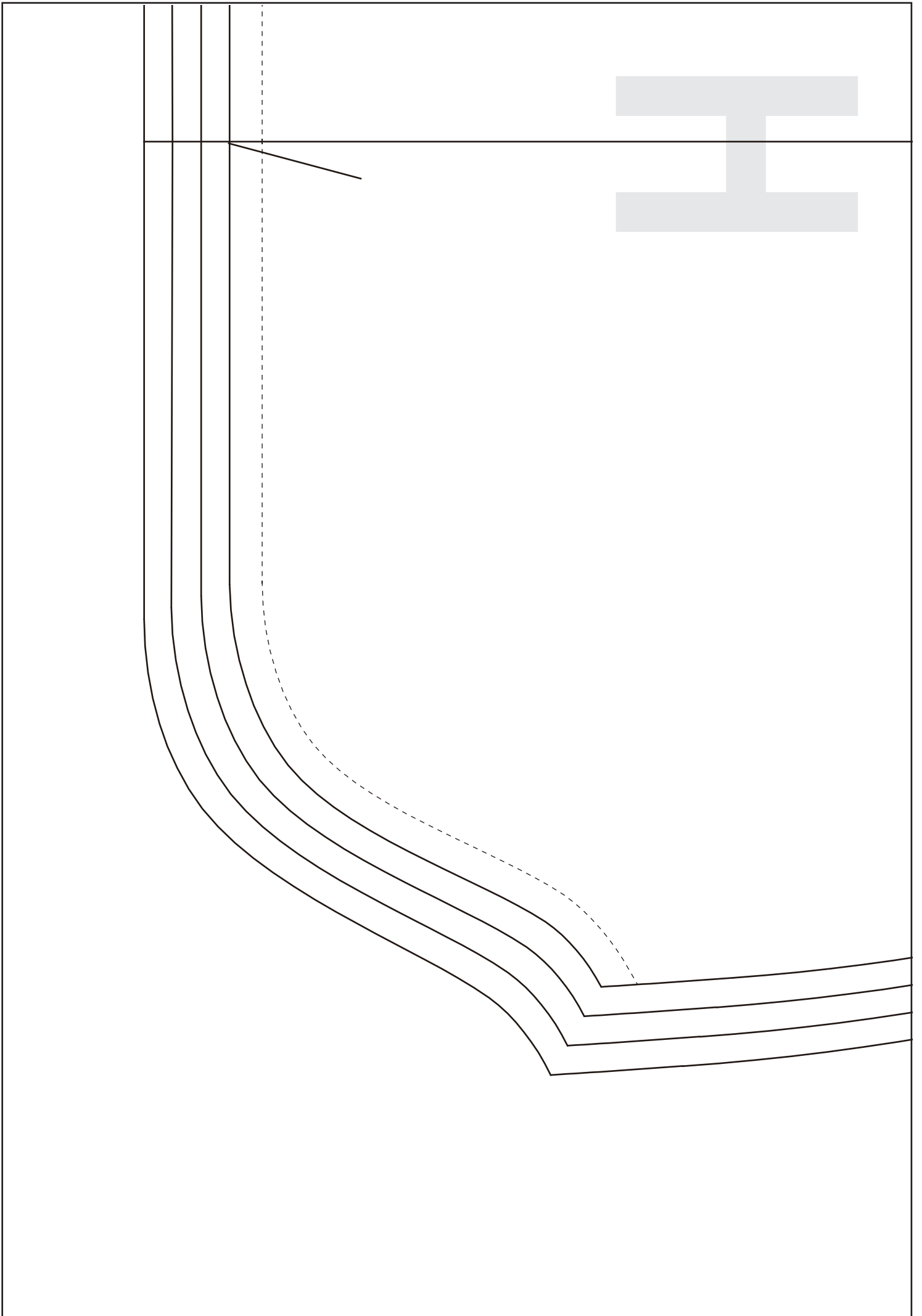

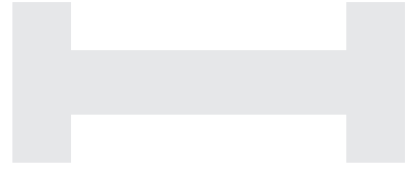

ダーツ位置

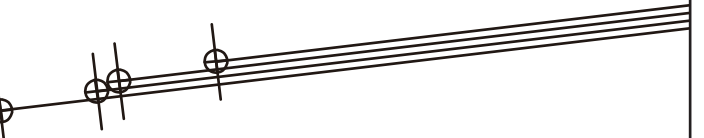

ダーツ位置

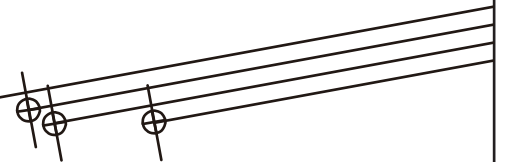

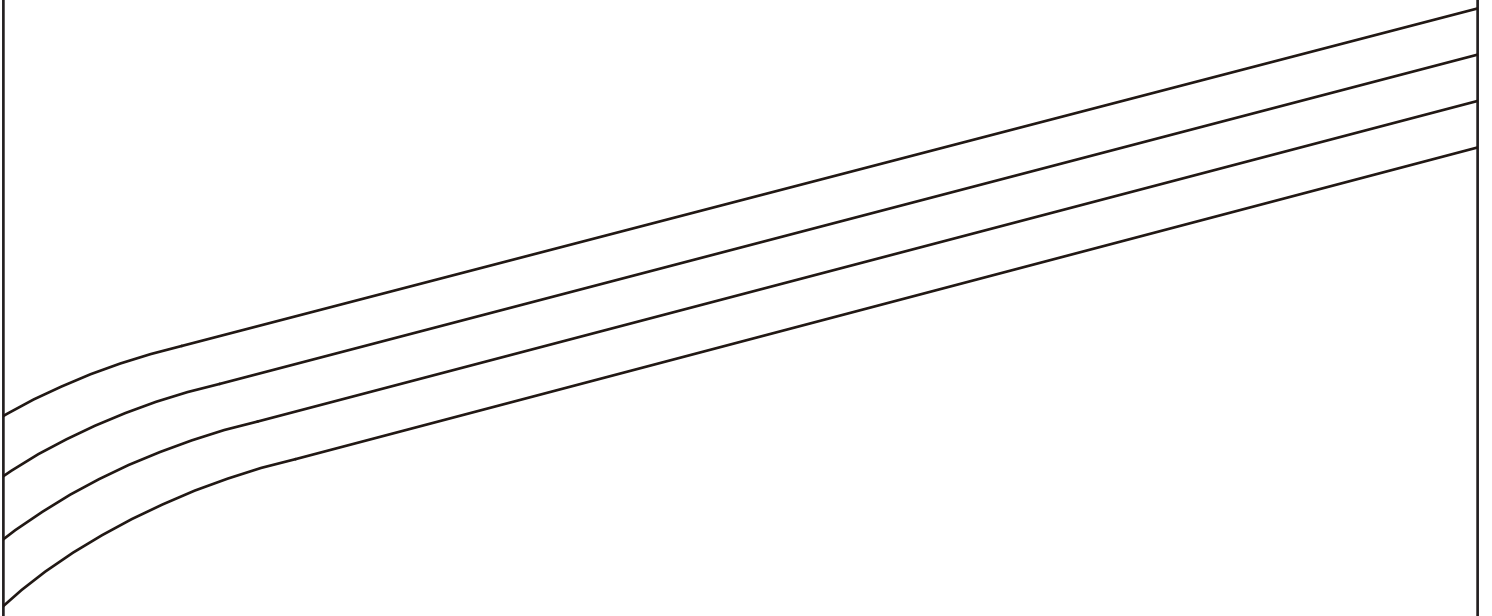

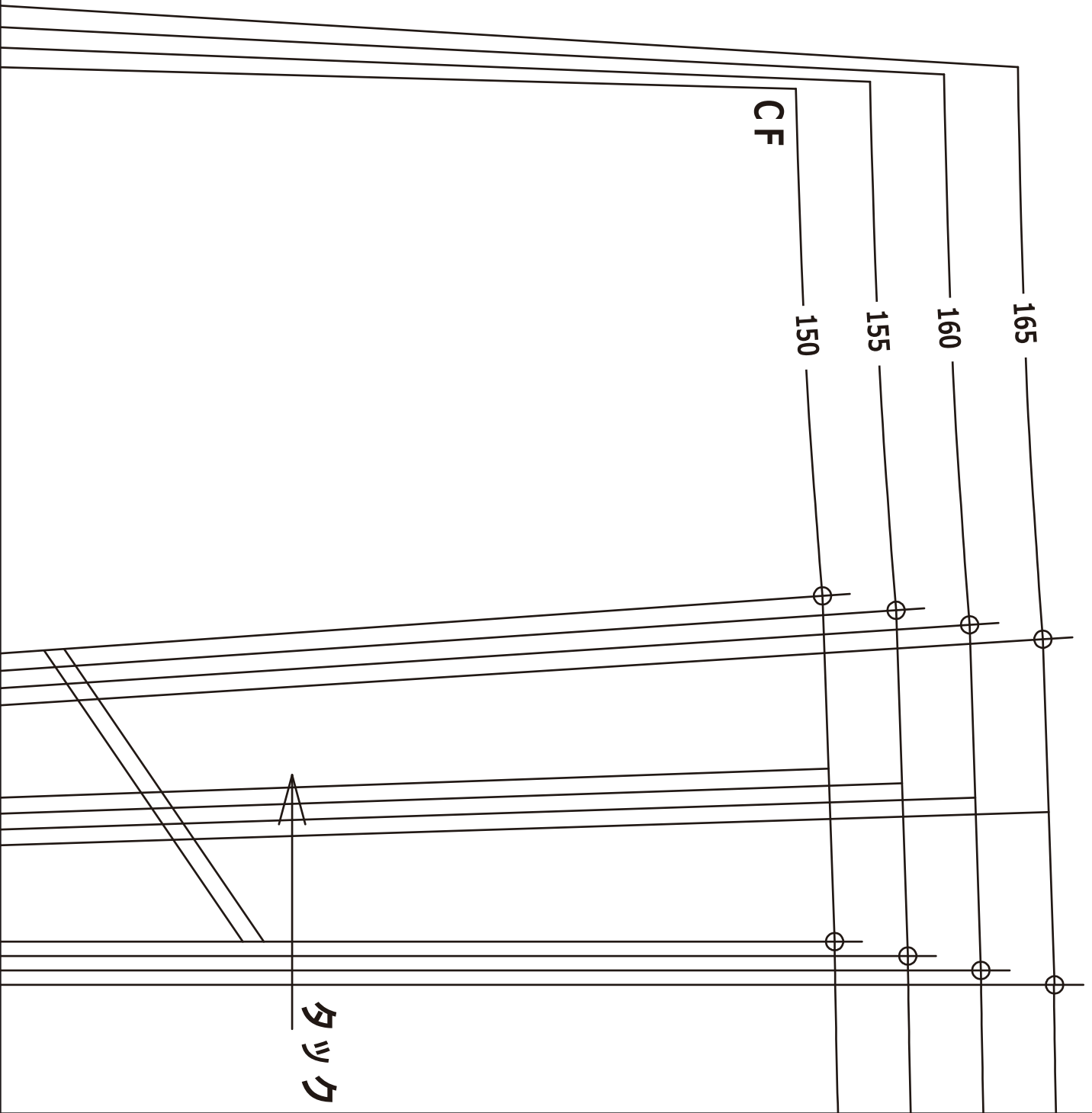

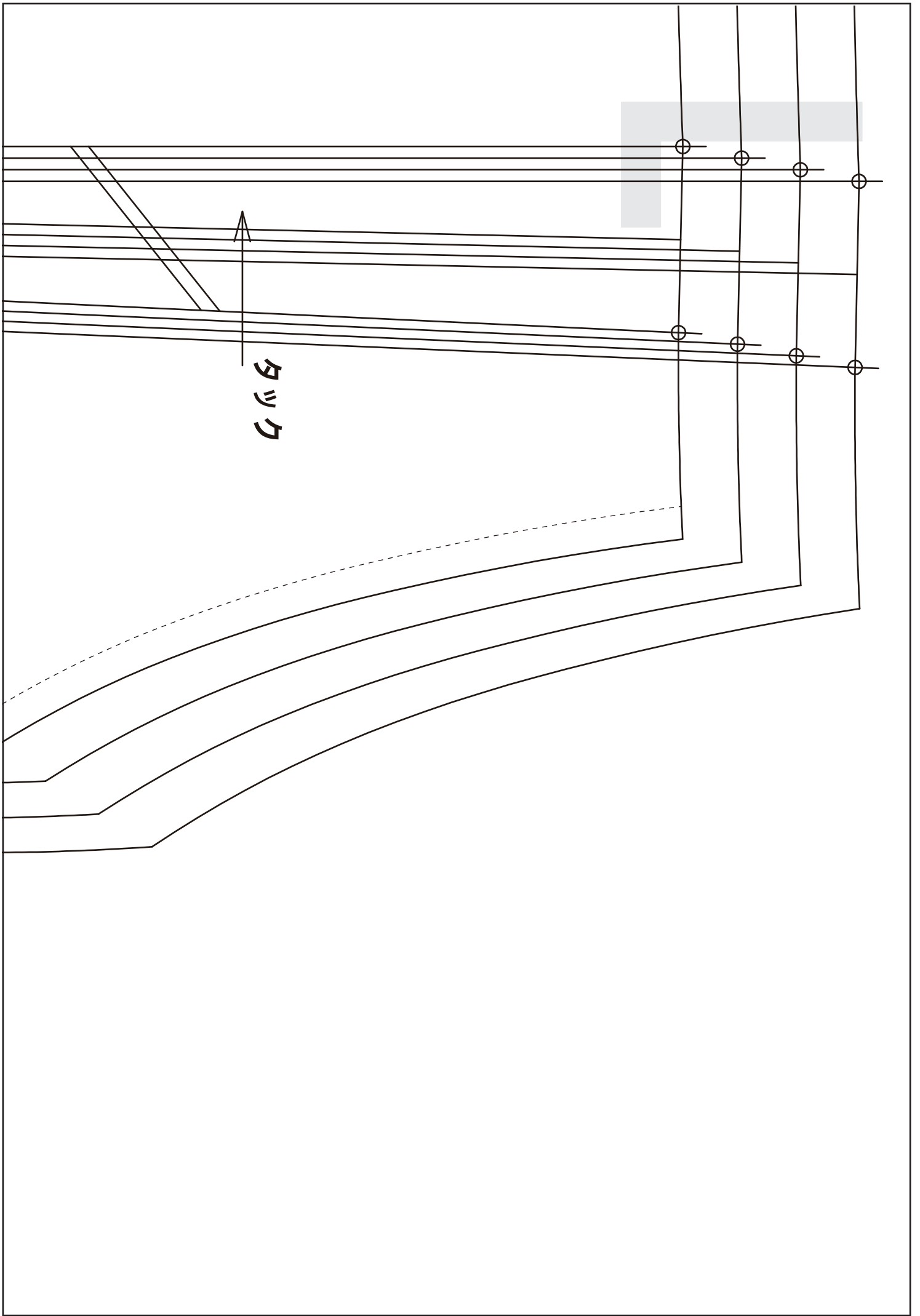

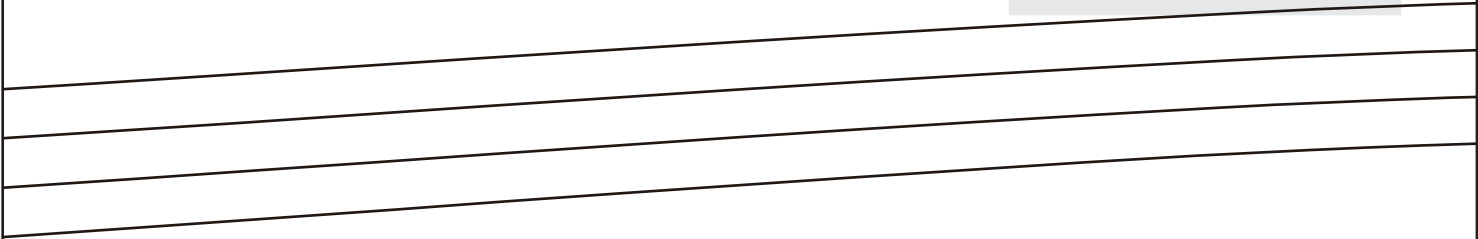
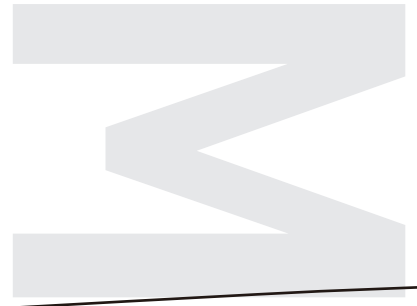

N

PALLET

FR2300

B : 後身頃

表地 × 2

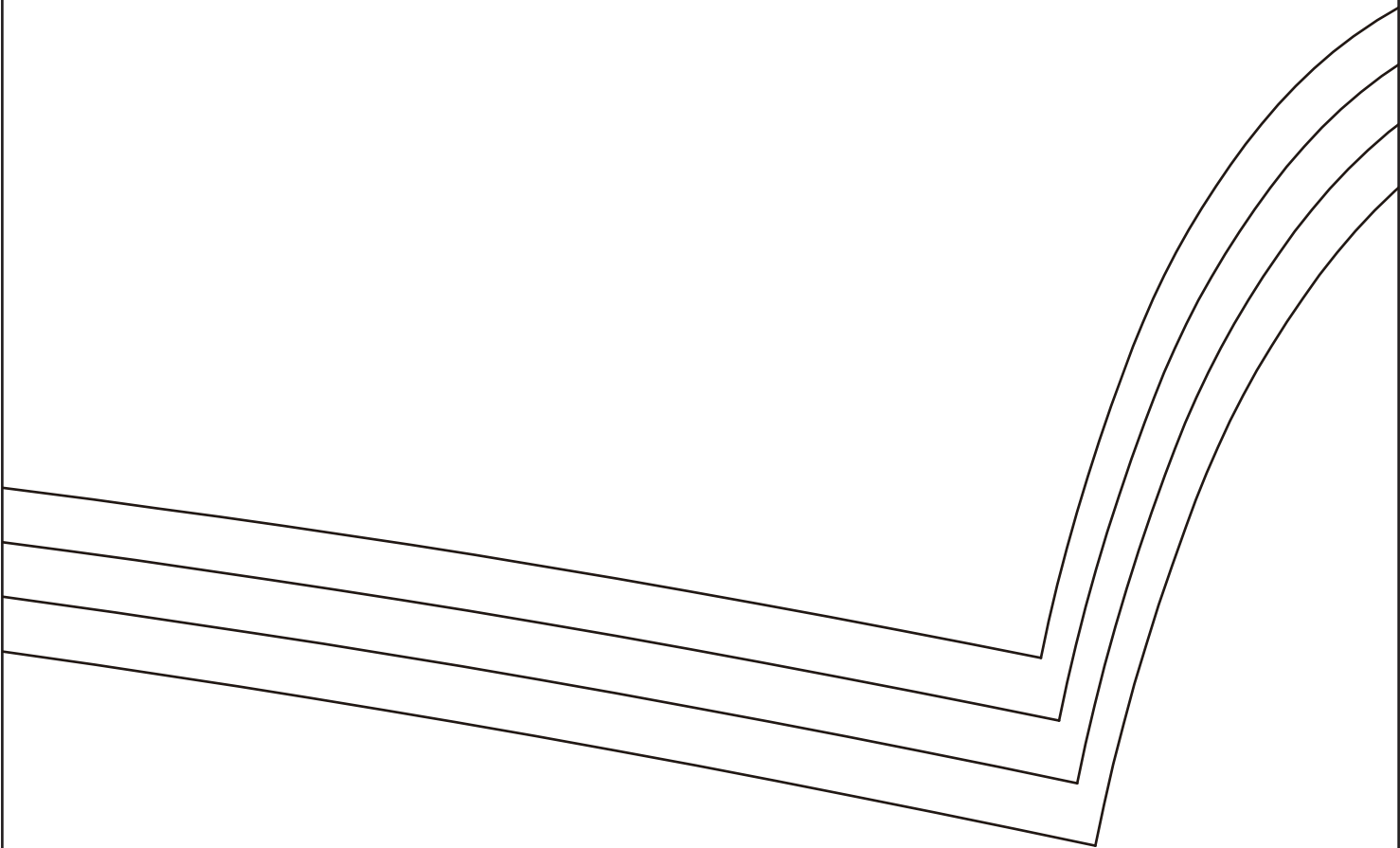

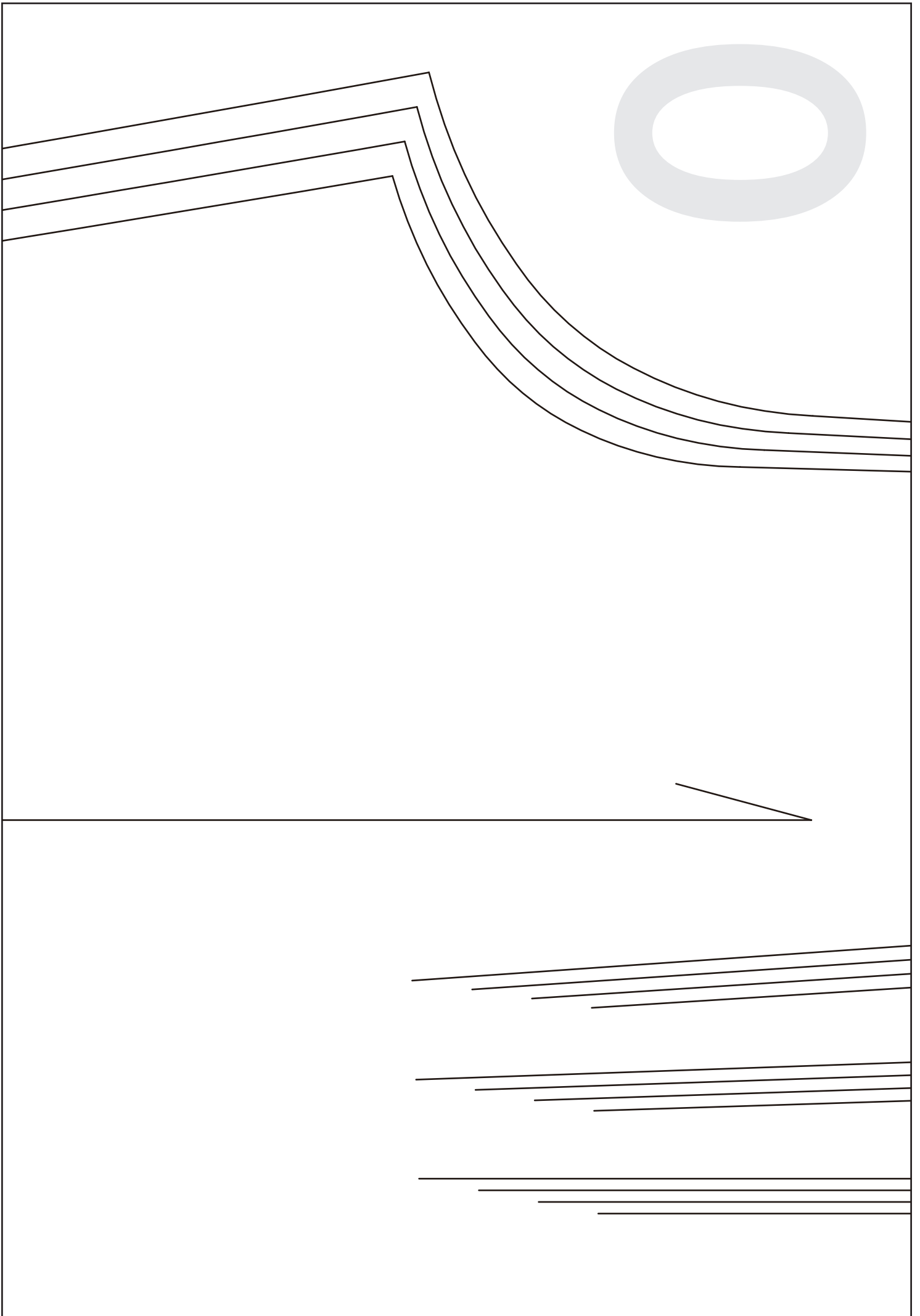

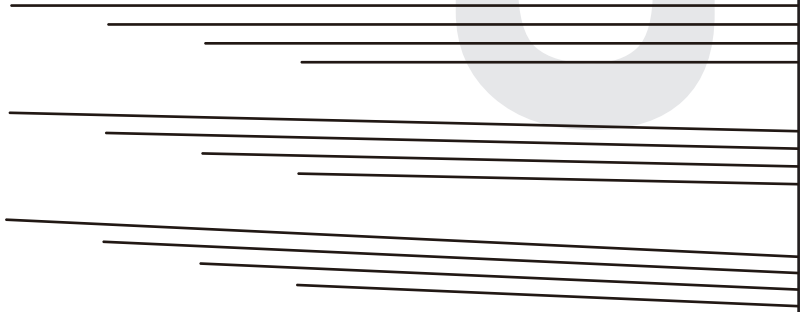
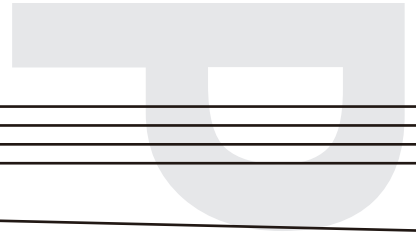

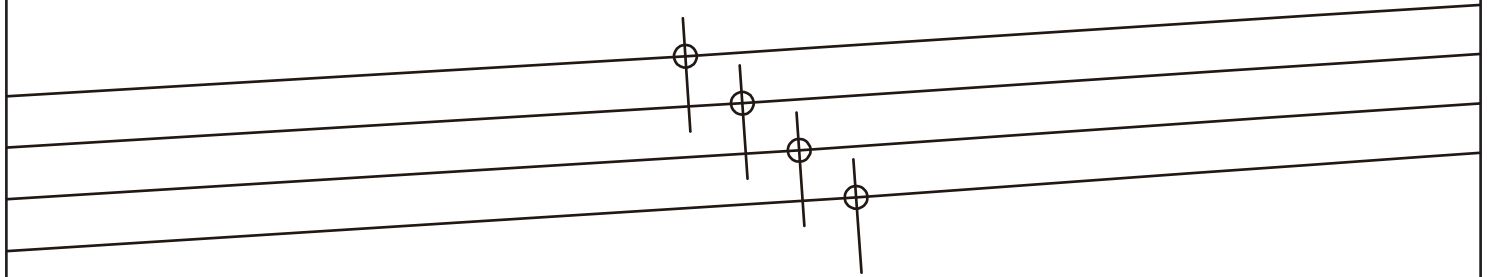

R

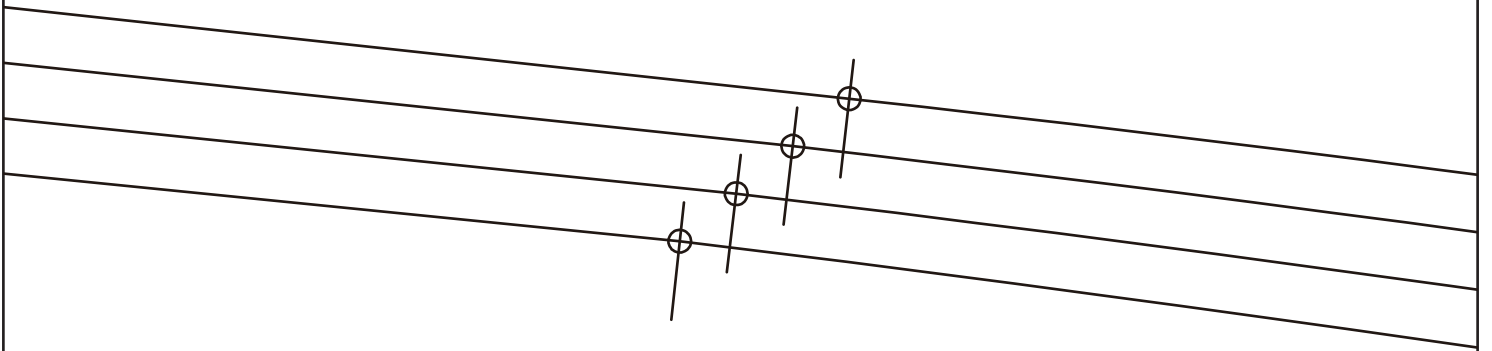

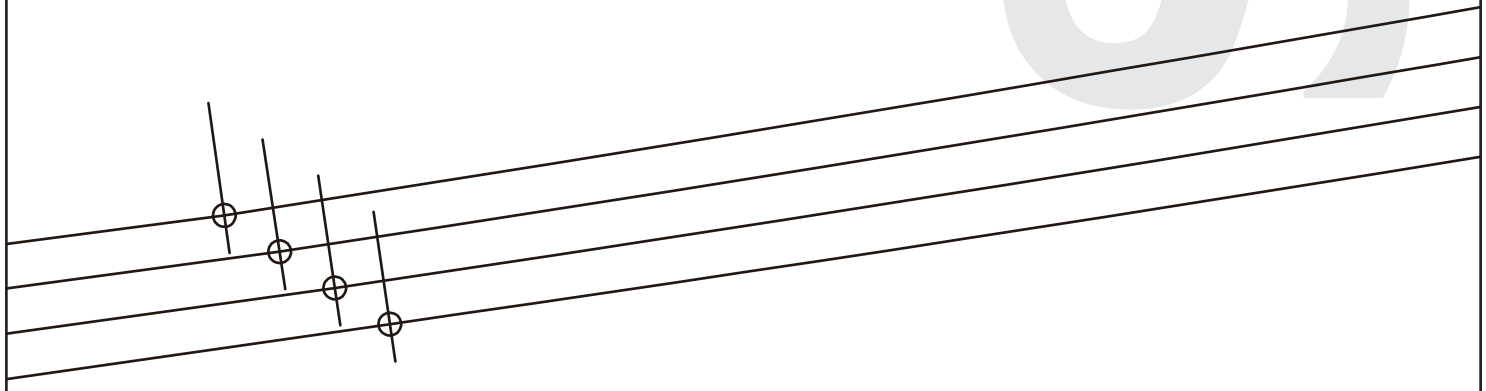



PALLET
FR2300
A : 前身頃
表地 × 2

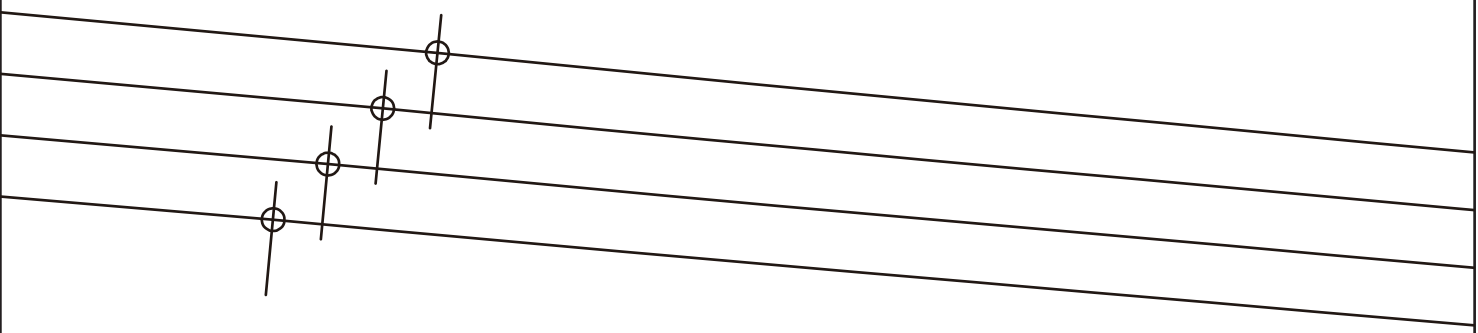

U

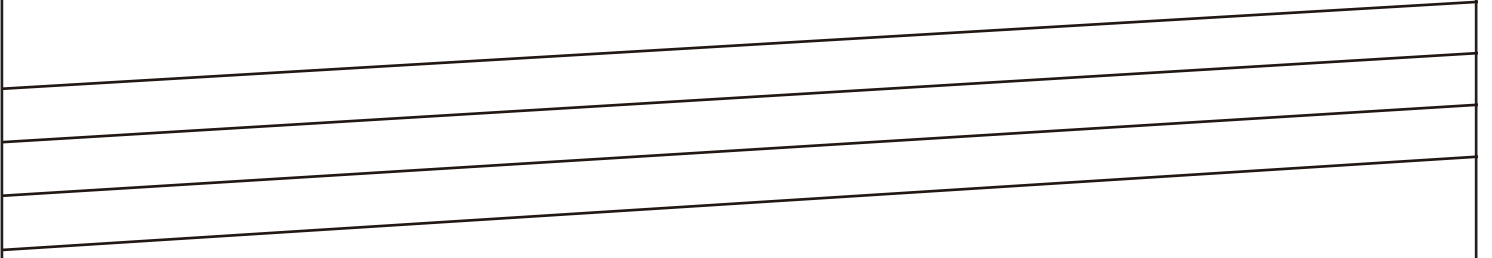

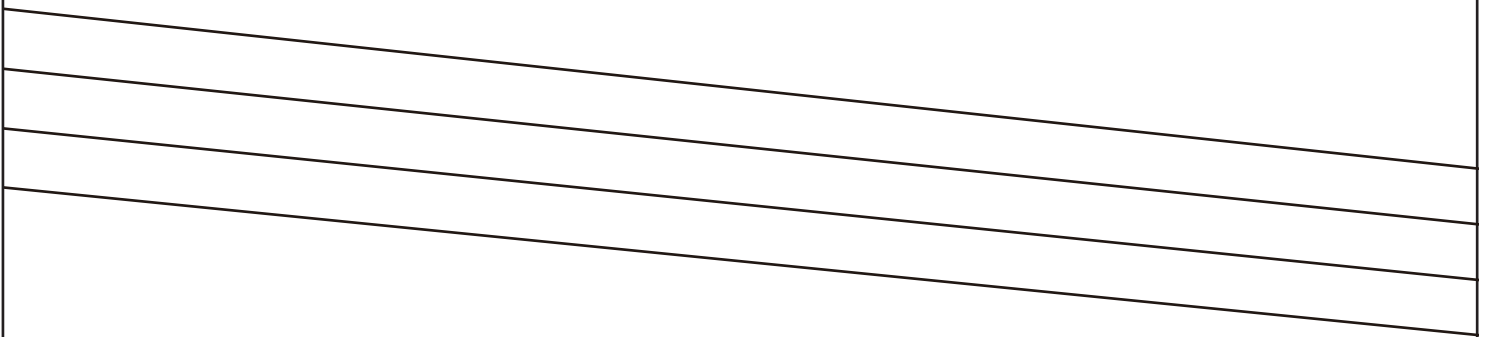

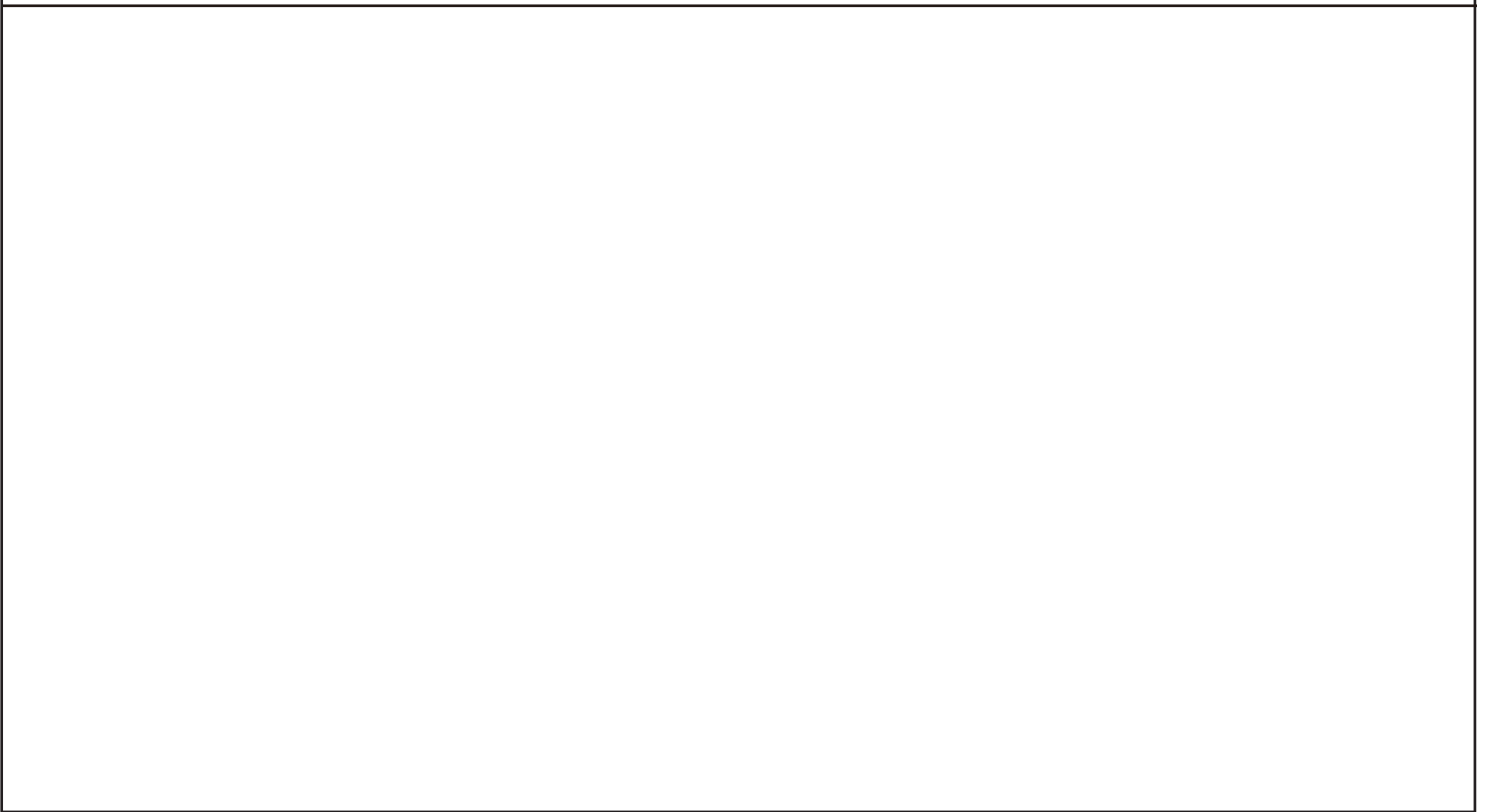
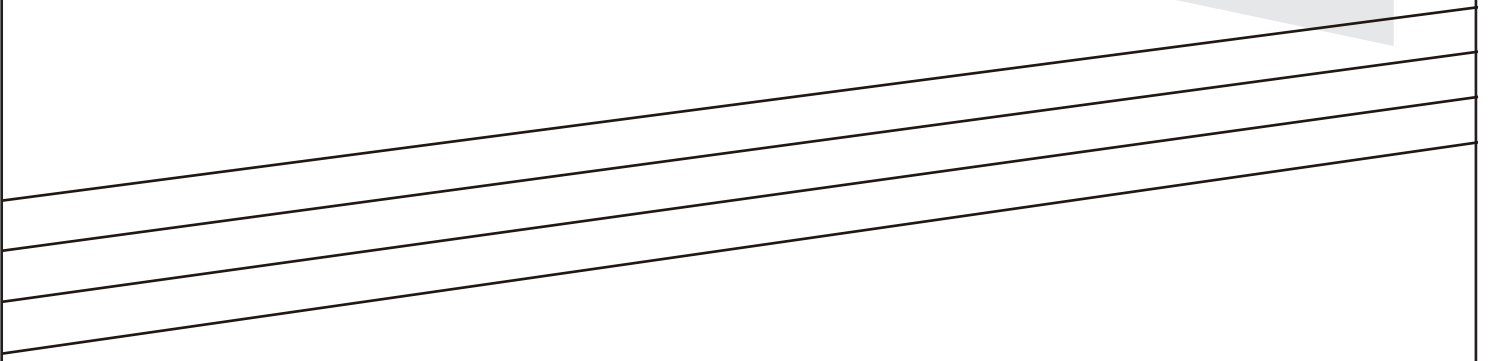

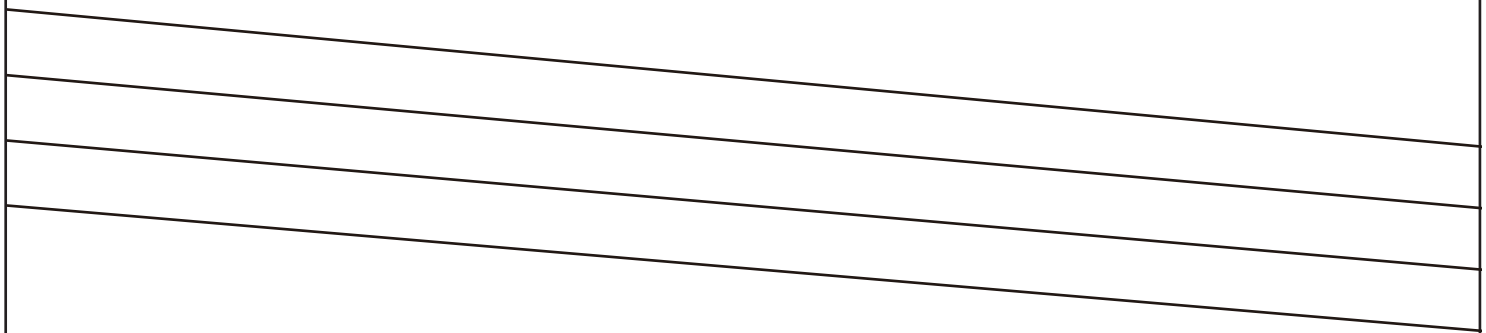

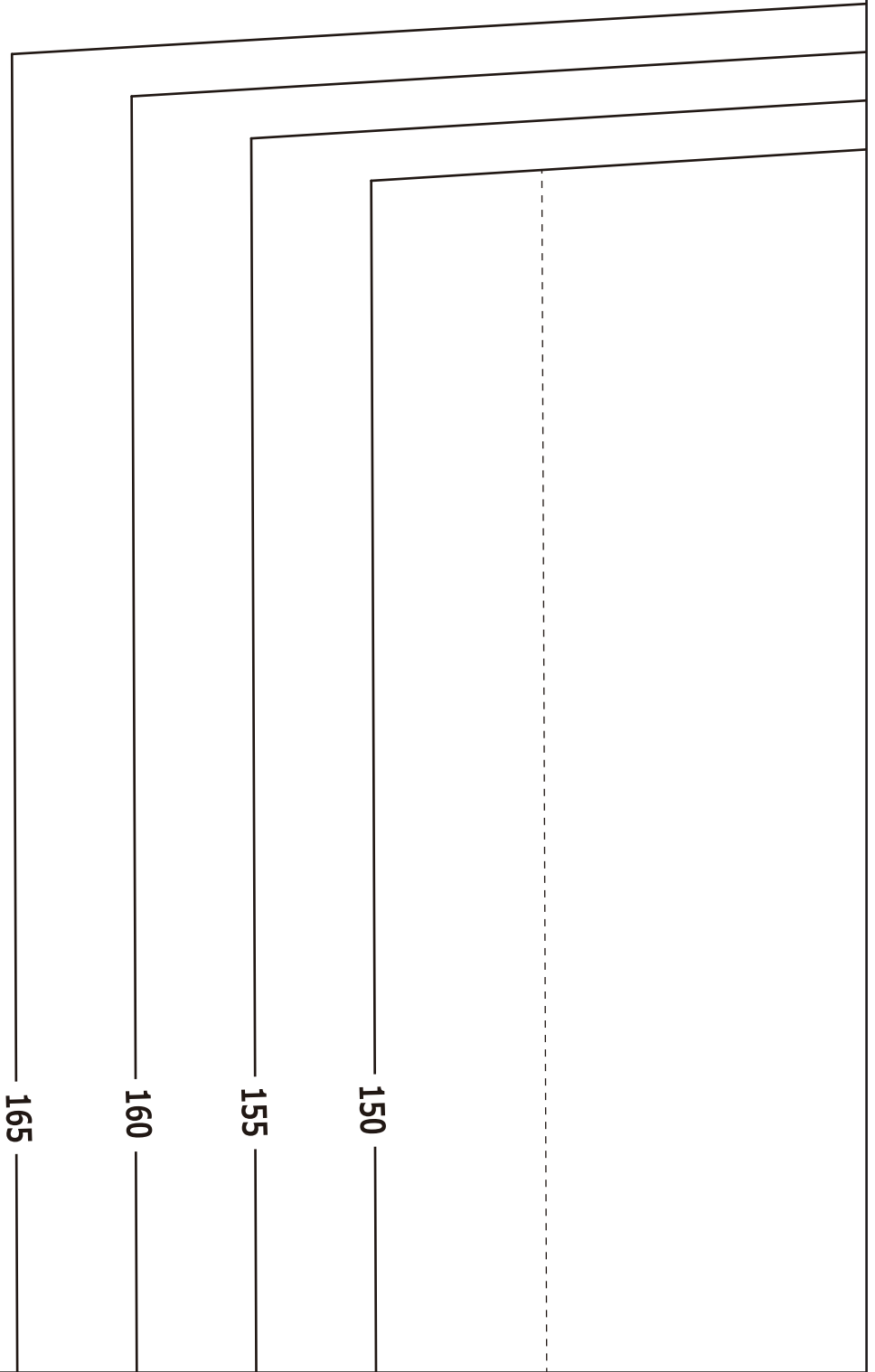

150

155

160

165

n

AA

✓

A B



150

155

160

165